

IRRC™

The AirBorn stackable compliant connector family is one of AirBorn's solutions for high-density, board-to-board stacking applications. This connector family is available in 0.075" contact spacing and 100 Ω and 85 Ω differential serial buses.

- Wide variety of standard pin/tail lengths accommodate any board-to-board spacing
- 0.075" contact spacing
- Reliable "eye of the needle"-compliant section design eliminates soldering
- BeCu contacts (special high-conductivity, high-temperature alloy)
- Very robust socket contact (low-stress design)
- Individually repairable contacts

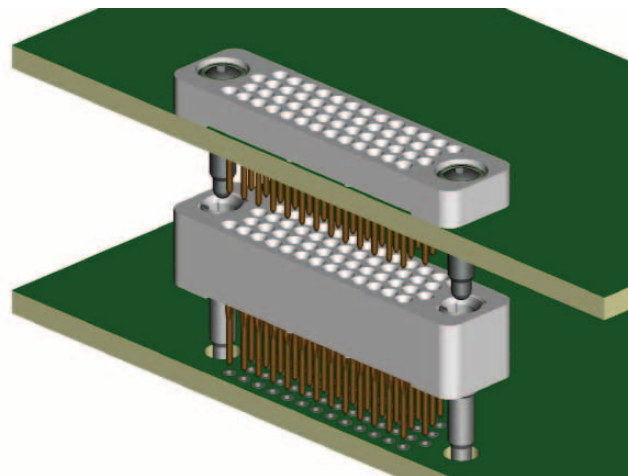



Stackable, Press-Fit, Compliant Pin/Socket

Contact spacing: 0.075" (1.91 mm)

A high-density press-fit mounted connector using patented stacking contacts consisting of a female/compliant/male configuration used in board-to-board stacking applications.

DIMENSIONS

SIZE	A	B	C
28	1.014	0.784	0.450
52	1.464	1.234	0.900
76	1.914	1.684	1.350
100	2.364	2.134	1.800
128	2.889	2.659	2.325
152	3.339	3.109	2.775
200	4.239	4.009	3.675
252	5.214	4.984	4.650
300	6.114	5.884	5.550

Tolerances: ± 0.010"

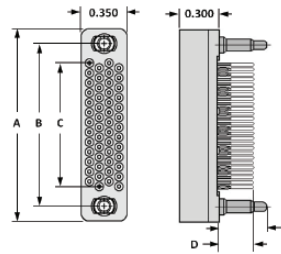

CONTACT SELECTION	CONTACT D	HARDWARE E
10	0.095	0.195
20	0.270	0.370
21	0.300	0.400
22	0.400	0.500
23	0.500	0.600
24	0.700	0.800
25	0.800	0.900
26	0.900	1.000
27	0.600	0.700
28	1.000	1.100

Sample Part Number Format: RC422-052-211-4000

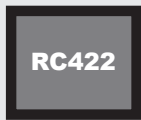

SERIES
Stackable
Compliant
Full-Profile
4 Rows
0.075" Spacing



CONFIGURATION
028 – 4 Rows/7 Columns
052 – 4 Rows/13 Columns
076 – 4 Rows/19 Columns
100 – 4 Rows/25 Columns
128 – 4 Rows/32 Columns
152 – 4 Rows/38 Columns
200 – 4 Rows/50 Columns
252 – 4 Rows/63 Columns
300 – 4 Rows/75 Columns

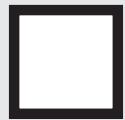

PLATING
1 – 50 μ" Au
3 – 30 μ" Au
7 – 50 μ" Au / 20 μ" Au
9 – 30 μ" Au / 20 μ" Au

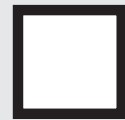

TYPE
00 – None
FT – Female thread
MT – Male thread
(#39 hardware, only)

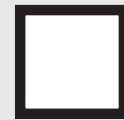

VARIATION
Blank – None
XXX – Consult factory

CONTACT
10 – 0.095" Long
20 – 0.270" Long
21 – 0.300" Long
22 – 0.400" Long
23 – 0.500" Long
24 – 0.700" Long
25 – 0.800" Long
26 – 0.900" Long
27 – 0.600" Long
28 – 1.000" Long
30 – 0.270" Long
31 – 0.300" Long
32 – 0.400" Long
33 – 0.500" Long
34 – 0.700" Long
35 – 0.800" Long
36 – 0.900" Long
37 – 0.600" Long
38 – 1.000" Long

HARDWARE
30 – 0.195" Long (use with #10 contact)
39 – 0.370" Long (use with #20 contact)
40 – 0.400" Long (use with #21 contact)
41 – 0.500" Long (use with #22 contact)
42 – 0.600" Long (use with #23 contact)
43 – 0.800" Long (use with #24 contact)
44 – 0.900" Long (use with #25 contact)
45 – 1.000" Long (use with #26 contact)
46 – 0.700" Long (use with #27 contact)
47 – 1.100" Long (use with #28 contact)



PLEASE CONSULT THE AIRBORNE WEBSITE FOR THE LATEST REVISION OF THIS DOCUMENT PRIOR TO BEGINNING ANY DESIGN WORK.

MATED HEIGHT

The connector body height is 0.300" and, when used with the -20 or -30 (0.270") contact, the mounting is flush (board-bottom-mounted to connector top). This board-bottom to connector-top spacing can be modified based on the contact selected by approximately the difference in pin length (see Table 2 in top window).

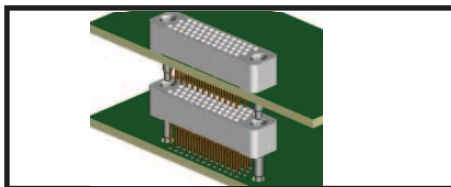
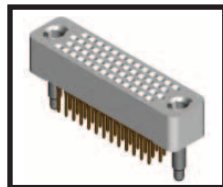

MATERIALS and FINISHES

Contact: BeCu per ASTM B768 (BeCu C17410 brush alloy 174)
Contact Finish: Gold per MIL-G-45204 over nickel per IAW QQ-N-290
Molded Insulator: Glass-filled polyphenylene sulfide (PPS) per MIL-M-24519
Hardware: Stainless steel per ASTM A582, passivated per ASTM 967
Guide Pin/Socket: BeCu per ASTM B196/197, nickel-plated per QQ-N-290

NOTE: AirBorn can manufacture special configurations to your exact specifications.

PERFORMANCE

Contact Rating: 3 amperes
Operating Temperature: -65° C to +125° C
Insulation Resistance: 5,000 megaohms minimum @ 500 VDC
Durability: 500 connector mating cycles
Contact Resistance: 3 to 5 milliohms (contact length-dependent)
Contact Engagement Force: 4.0 oz (113 g) max. w/0.0246" dia. test pin
Contact Separation Force: 0.5 oz (14 g) min. w/0.0226" dia. test pin
Compliant Insertion Force: 22.5 lb (10.21 Kg) max. per contact
Compliant Removal Force: 4.5 lb (2.04 Kg) min. per contact

SI DATA – Differential 100 Ohm

1	Diff. Insertion Loss	5.0 GHz @ -3 dB
2	Diff. Return Loss	2.0 GHz @ -8 dB
3	NEXT	4.0 GHz @ -25 dB
4	FEXT	4.0 GHz @ -35 dB



Stackable, Press-Fit, Compliant Pin/Socket

Contact spacing: 0.075" (1.91 mm)

A high-density press-fit mounted connector using patented stacking contacts consisting of a female/compliant/male configuration used in board-to-board stacking applications.

DIMENSIONS

TABLE 1			
SIZE	A	B	C
28	1.014	0.784	0.450
52	1.464	1.234	0.900
76	1.914	1.684	1.350
100	2.364	2.134	1.800
128	2.889	2.659	2.325
152	3.339	3.109	2.775
200	4.239	4.009	3.675
252	5.214	4.984	4.650
300	6.114	5.884	5.550

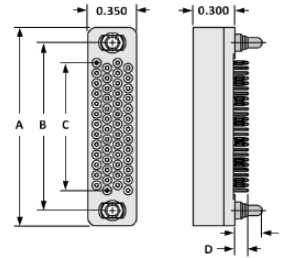

TABLE 2		
CONTACT SELECTION	CONTACT D	HARDWARE E
10	0.095	0.195

Tolerances: ± 0.010"

Sample Part Number Format: RC422-052-101-3000



SERIES
Stackable
Compliant
Full-Profile
4 Rows
0.075" Spacing



CONFIGURATION
028 – 4 Rows/7 Columns
052 – 4 Rows/13 Columns
076 – 4 Rows/19 Columns
100 – 4 Rows/25 Columns
128 – 4 Rows/32 Columns
152 – 4 Rows/38 Columns
200 – 4 Rows/50 Columns
252 – 4 Rows/63 Columns
300 – 4 Rows/75 Columns

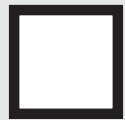

PLATING
1 – 50 μ" Au
3 – 30 μ" Au
7 – 50 μ" Au / 20 μ" Au
9 – 30 μ" Au / 20 μ" Au

CONTACT
10 - 0.095" Long



HARDWARE
30 - 0.195" Long
(use with #10 contact)

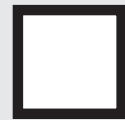

TYPE
00 – None
FT – Female thread



VARIATION
Blank – None
XXX – Consult factory



PLEASE CONSULT THE AIRBORN WEBSITE FOR THE LATEST REVISION OF THIS DOCUMENT PRIOR TO BEGINNING ANY DESIGN WORK.

MATED HEIGHT

The connector body height is 0.300" and, when used with the -20 or -30 (0.270") contact, the mounting is flush (board-bottom-mounted to connector top). This board-bottom to connector-top spacing can be modified based on the contact selected by approximately the difference in pin length (see Table 2 in top window).

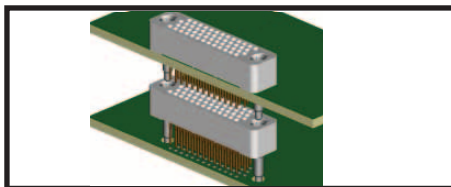
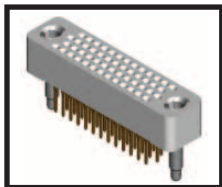

SI DATA – Differential 100 Ohm

1	Diff. Insertion Loss	5.0 GHz @ -3 dB
2	Diff. Return Loss	2.0 GHz @ -8 dB
3	NEXT	4.0 GHz @ -25 dB
4	FEXT	4.0 GHz @ -35 dB

MATERIALS and FINISHES

Contact: BeCu per ASTM B768 (BeCu C17410 brush alloy 174)
Contact Finish: Gold per MIL-G-45204 over nickel per IAW QQ-N-290
Molded Insulator: Glass-filled polyphenylene sulfide (PPS) per MIL-M-24519
Hardware: Stainless steel per ASTM A582, passivated per ASTM 967
Guide Pin/Socket: BeCu per ASTM B196/197, nickel-plated per QQ-N-290

NOTE: AirBorn can manufacture special configurations to your exact specifications.

PERFORMANCE

Contact Rating: 3 amperes
Operating Temperature: -65° C to +125° C
Insulation Resistance: 5,000 megaohms minimum @ 500 VDC
Durability: 500 connector mating cycles
Contact Resistance: 3 to 5 milliohms (contact length-dependent)
Contact Engagement Force: 4.0 oz (113 g) max. w/0.0246" dia. test pin
Contact Separation Force: 0.5 oz (14 g) min. w/0.0226" dia. test pin
Compliant Insertion Force: 22.5 lb (10.21 Kg) max. per contact
Compliant Removal Force: 4.5 lb (2.04 Kg) min. per contact



Stackable, Press-Fit, Compliant Pin/Socket

Contact spacing: 0.075" (1.91 mm)

A high-density press-fit mounted connector using patented stacking contacts consisting of a female/compliant/male configuration used in board-to-board stacking applications.

DIMENSIONS

TABLE 1			
SIZE	A	B	C
28	1.014	0.784	0.450
52	1.464	1.234	0.900
76	1.914	1.684	1.350
100	2.364	2.134	1.800
128	2.889	2.659	2.325
152	3.339	3.109	2.775
200	4.239	4.009	3.675
252	5.214	4.984	4.650
300	6.114	5.884	5.550

Tolerances: ± 0.010"

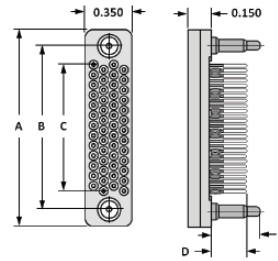

TABLE 2		
CONTACT SELECTION	CONTACT D	HARDWARE E
30	0.270	0.370
31	0.300	0.400
32	0.400	0.500
33	0.500	0.600
34	0.700	0.800
35	0.800	0.900
36	0.900	1.000
37	0.600	0.700
38	1.000	1.100

Sample Part Number Format: RC442-052-311-4000



SERIES
Stackable
Compliant
Low-Profile
4 Rows
0.075" Spacing



CONFIGURATION
028 – 4 Rows/7 Columns
052 – 4 Rows/13 Columns
076 – 4 Rows/19 Columns
100 – 4 Rows/25 Columns
128 – 4 Rows/32 Columns
152 – 4 Rows/38 Columns
200 – 4 Rows/50 Columns
252 – 4 Rows/63 Columns
300 – 4 Rows/75 Columns

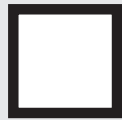

PLATING
1 – 50 μ" Au
3 – 30 μ" Au
7 – 50 μ" Au / 20 μ" Au
9 – 30 μ" Au / 20 μ" Au



TYPE
00 – None



VARIATION
Blank – None
XXX – Consult factory

HARDWARE

39 – 0.370" Long (use with #30 contact)
40 – 0.400" Long (use with #31 contact)
41 – 0.500" Long (use with #32 contact)
42 – 0.600" Long (use with #33 contact)
43 – 0.800" Long (use with #34 contact)
44 – 0.900" Long (use with #35 contact)
45 – 1.000" Long (use with #36 contact)
46 – 0.700" Long (use with #37 contact)
47 – 1.100" Long (use with #38 contact)



PLEASE CONSULT THE AIRBORN WEBSITE FOR THE LATEST REVISION OF THIS DOCUMENT PRIOR TO BEGINNING ANY DESIGN WORK.

MATED HEIGHT

The connector body height is 0.150" but the functional spacing (the bottom surface of the board, on which the connector is mounted, to the top of the connector below it) can be modified based on the contact/pin length selected (see Table 2 in top window).

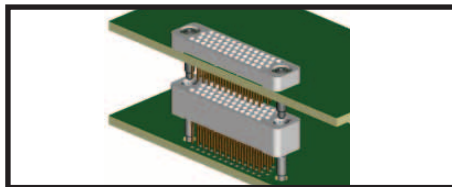
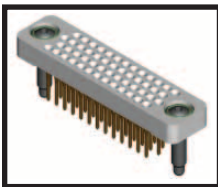

MATERIALS and FINISHES

Contact: BeCu per ASTM B768 (BeCu C17410 brush alloy 174)
Contact Finish: Gold per MIL-G-45204 over nickel per IAW QQ-N-290
Molded Insulator: Glass-filled polyphenylene sulfide (PPS) per MIL-M-24519
Hardware: Stainless steel per ASTM A582, passivated per ASTM 967
Guide Pin/Socket: BeCu per ASTM B196/197, nickel-plated per QQ-N-290

NOTE: AirBorn can manufacture special configurations to your exact specifications.

PERFORMANCE

Contact Rating: 3 amperes
Operating Temperature: -65° C to +125° C
Insulation Resistance: 5,000 megaohms minimum @ 500 VDC
Durability: 500 connector mating cycles
Contact Resistance: 3 to 5 milliohms (contact length dependent)
Contact Engagement Force: 4.0 oz (113 g) max. w/0.0246" dia. test pin
Contact Separation Force: 0.5 oz (14 g) min. w/0.0226" dia. test pin
Compliant Insertion Force: 22.5 lb (10.21 Kg) max. per contact
Compliant Removal Force: 4.5 lb (2.04 Kg) min. per contact

SI DATA – Differential 100 Ohm

1	Diff. Insertion Loss	5.0 GHz @ -3 dB
2	Diff. Return Loss	2.0 GHz @ -8 dB
3	NEXT	4.0 GHz @ -25 dB
4	FEXT	4.0 GHz @ -35 dB



Stackable, Press-Fit, Compliant Pin/Socket

Contact spacing: 0.075" (1.91 mm)

A high-density bottom-of-the-stack cable mate connector configuration used for bottom-compliant connector mating applications.

DIMENSIONS

TABLE 1			
SIZE	A	B	C
28	1.014	0.784	0.450
52	1.464	1.234	0.900
76	1.914	1.684	1.350
100	2.364	2.134	1.800
128	2.889	2.659	2.325
152	3.339	3.109	2.775

Tolerances: ± 0.010"

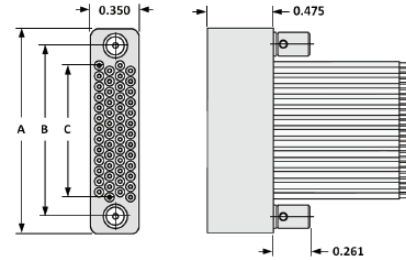

Sample Part Number Format: RC4B2-052-281-62ED



SERIES
Stackable
Compliant
Full-Profile
4 Rows
0.075" Spacing
Bottom-of-Stack
Cable Mate



CONFIGURATION
028 – 4 Rows/7 Columns
052 – 4 Rows/13 Columns
076 – 4 Rows/19 Columns
100 – 4 Rows/25 Columns
128 – 4 Rows/32 Columns
152 – 4 Rows/38 Columns



CONTACT
28 – Socket, crimp, 26-24 AWG
29 – Socket, crimp, 30-28 AWG



PLATING
1 – 50 µ" Au
3 – 30 µ" Au



HARDWARE
00 – None
58 – Guide socket, non-polarized
62 – Jacksocket, hex, turning



TYPE
00 – None
XX – See Wire Codes



VARIATION
Blank – None
XXX – Consult factory

WIRE CODES

TYPE and COLOR			LENGTH	
Code	Size	Color	Code	Length (+1"/-0")
Mil-W-16878/4				
C	24 awg	Ten repeating	A	6"
D	24 awg	White	B	12"
E	26 awg	Ten repeating	C	18"
F	26 awg	White	D	24"
G	28 awg	Ten repeating	E	30"
H	28 awg	White	F	36"
J	30 awg	Ten repeating	G	42"
K	30 awg	White	H	48"
Mil-W-22759/33				
N	24 awg	Ten repeating	J	54"
P	24 awg	White	K	60"
R	26 awg	Ten repeating	L	66"
S	26 awg	White	M	72"
T	28 awg	Ten repeating	N	84"
U	28 awg	White	P	96"
V	30 awg	Ten repeating	R	108"
W	30 awg	White	S	120"

PLEASE CONSULT THE AIRBORNE WEBSITE FOR THE LATEST REVISION OF THIS DOCUMENT PRIOR TO BEGINNING ANY DESIGN WORK.

MATED HEIGHT

Connector body height is 0.475" and is designed to mount flush to the board bottom of the mating connector.

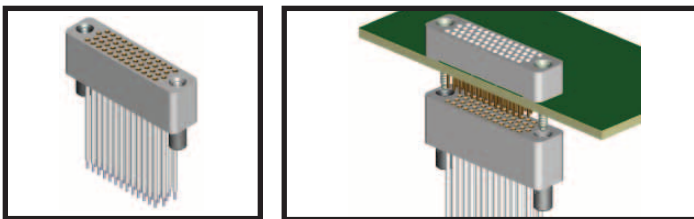

NOTES

- The RC4B2 connector is designed to mate with an RC422 connector using contact option -21 (0.270" long) and -39MT hardware. This contact length and hardware combination assures proper connector mating when using boards having a thickness of 0.058"-0.125".
- When guide hardware is required on the RC4B2 connector, use hardware option -3900 on the mating connector.
- When jacksocket hardware is required on the RC4B2 connector, use hardware option -39MT on the mating connector.

MATERIALS and FINISHES

Contact: BeCu per ASTM B196 or B197 (BeCu alloy 172 or 173)
Contact Finish: Gold per MIL-G-45204 over nickel per QQ-N-290
Molded Insulator: Glass-filled polyphenylene sulfide (PPS) per MIL-M-24519
Hardware: Stainless steel per ASTM A484/A484M and ASTM A582/A582M, passivated per SAE AMS-2700

NOTE: AirBorn can manufacture special configurations to your exact specifications.

PERFORMANCE

Contact Rating: 3 amperes
Operating Temperature: -65° C to +125° C
Insulation Resistance: 5,000 megaohms minimum @ 500 VDC
Durability: 500 connector mating cycles
Contact Resistance: 3 to 5 milliohms (contact length dependent)
Contact Engagement Force: 4.0 oz (113 g) max. w/0.0246" dia. test pin
Contact Separation Force: 0.5 oz (14 g) min. w/0.0226" dia. test pin



Stackable, Press-Fit, Compliant Pin/Socket

Contact spacing: 0.075" (1.91 mm)

A high-density top-of-the-stack cable mate connector configuration used for top-compliant connector mating applications.

DIMENSIONS

TABLE 1			
SIZE	A	B	C
28	1.014	0.784	0.450
52	1.464	1.234	0.900
76	1.914	1.684	1.350
100	2.364	2.134	1.800
128	2.889	2.659	2.325
152	3.339	3.109	2.775

Tolerances: ± 0.010"

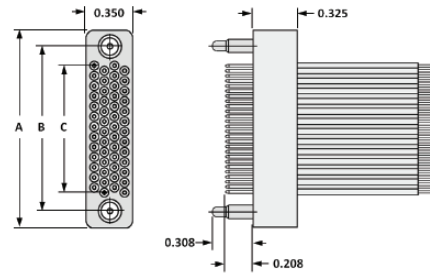

Sample Part Number Format: RC4C2-052-181-57ED



SERIES
Stackable
Compliant
Full-Profile
4 Rows
0.075" Spacing
Top-of-Stack
Cable Mate



CONFIGURATION
028 – 4 Rows/7 Columns
052 – 4 Rows/13 Columns
076 – 4 Rows/19 Columns
100 – 4 Rows/25 Columns
128 – 4 Rows/32 Columns
152 – 4 Rows/38 Columns



PLATING
1 – 50 µ" Au
3 – 30 µ" Au



CONTACT
18 – Pin, crimp, 26-24 AWG
19 – Pin, crimp, 30-28 AWG



HARDWARE
00 – None
57 – Guide pin, non-polarized
61 – Jackscrew, hex, turning*



VARIATION
Blank – None
XXX – Consult factory

WIRE CODES

TYPE and COLOR			LENGTH	
Code	Size	Color	Code	Length (+1"/-0")
Mil-W-16878/4				
C	24 awg	Ten repeating	A	6"
D	24 awg	White	B	12"
E	26 awg	Ten repeating	C	18"
F	26 awg	White	D	24"
G	28 awg	Ten repeating	E	30"
H	28 awg	White	F	36"
J	30 awg	Ten repeating	G	42"
K	30 awg	White	H	48"
Mil-W-22759/33				
N	24 awg	Ten repeating	L	66"
P	24 awg	White	M	72"
R	26 awg	Ten repeating	N	84"
S	26 awg	White	P	96"
T	28 awg	Ten repeating	R	108"
U	28 awg	White	S	120"
V	30 awg	Ten repeating		
W	30 awg	White		

PLEASE CONSULT THE AIRBORNE WEBSITE FOR THE LATEST REVISION OF THIS DOCUMENT PRIOR TO BEGINNING ANY DESIGN WORK.

MATED HEIGHT

Connector body height is 0.325" and is designed to mount flush to the mating connector.

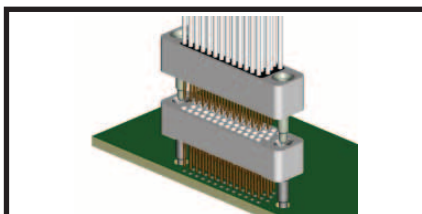
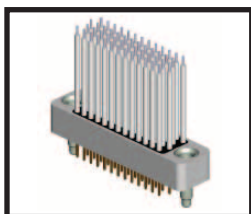

MATERIALS and FINISHES

Contact: BeCu per ASTM B196 or B197 (BeCu alloy 172 or 173)
Contact Finish: Gold per MIL-G-45204 over nickel per QQ-N-290
Molded Insulator: Glass-filled polyphenylene sulfide (PPS) per MIL-M-24519
Hardware: Stainless steel per ASTM A484/A484M and ASTM A582/A582M, passivated per SAE AMS-2700

NOTE: AirBorn can manufacture special configurations to your exact specifications.

PERFORMANCE

Contact Rating: 3 amperes
Operating Temperature: -65° C to +125° C
Insulation Resistance: 5,000 megaohms minimum @ 500 VDC
Durability: 500 connector mating cycles
Contact Resistance: 3 to 5 milliohms (contact length dependent)
Contact Engagement Force: 4.0 oz (113 g) max. w/0.0248" dia. test pin
Contact Separation Force: 0.5 oz (14 g) min. w/0.0226" dia. test pin

NOTES

* To use the -61 jackscrew hardware option, the fixed jacknut hardware (-XXMT) must be in place on the mating board connector.



Stackable, Press-Fit, Compliant Pin/Socket

Contact spacing: 0.075" (1.91 mm)

A high-density top-of-the-stack cable mate connector configuration used for top-compliant connector mating applications.

DIMENSIONS

TABLE 1			
SIZE	A	B	C
28	1.014	0.784	0.450
52	1.464	1.234	0.900
76	1.914	1.684	1.350
100	2.364	2.134	1.800
128	2.889	2.659	2.325
152	3.339	3.109	2.775

Tolerances: ± 0.010"

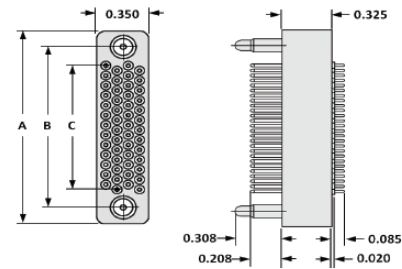

Sample Part Number Format: RC4C2-052-151-5700



SERIES
Stackable
Compliant
Full-Profile
4 Rows
0.075" Spacing
Top-of-Stack
Cable Mate

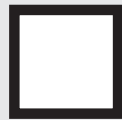

CONFIGURATION
028 – 4 Rows/7 Columns
052 – 4 Rows/13 Columns
076 – 4 Rows/19 Columns
100 – 4 Rows/25 Columns
128 – 4 Rows/32 Columns
152 – 4 Rows/38 Columns



CONTACT
15 – Pin, flex circuit



PLATING
1 – 50 µ" Au
3 – 30 µ" Au



HARDWARE
00 – None
57 – Guide pin, non-polarized
61 – Jackscrew, hex, turning*



TYPE
00 – None



VARIATION
Blank – None
XXX – Consult factory



PLEASE CONSULT THE AIRBORN WEBSITE FOR THE LATEST REVISION OF THIS DOCUMENT PRIOR TO BEGINNING ANY DESIGN WORK.

MATED HEIGHT

Connector body height is 0.325" and is designed to mount flush to the mating connector.

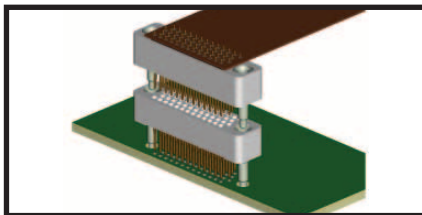
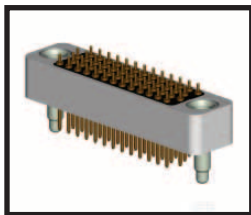

MATERIALS and FINISHES

Contact: BeCu per ASTM B196 or B197 (BeCu alloy 172 or 173)
Contact Finish: Gold per MIL-G-45204 over nickel per QQ-N-290
Molded Insulator: Glass-filled polyphenylene sulfide (PPS) per MIL-M-24519
Hardware: Stainless steel per ASTM A484/A484M and ASTM A582/A582M, passivated per SAE AMS-2700

NOTE: AirBorn can manufacture special configurations to your exact specifications.

PERFORMANCE

Contact Rating: 3 amperes
Operating Temperature: -65° C to +125° C
Insulation Resistance: 5,000 megaohms minimum @ 500 VDC
Durability: 500 connector mating cycles
Contact Resistance: 3 to 5 milliohms (contact length dependent)
Contact Engagement Force: 4.0 oz (113 g) max. w/0.0246" dia. test pin
Contact Separation Force: 0.5 oz (14 g) min. w/0.0226" dia. test pin

NOTES

* To use the -61 jackscrew hardware option, the fixed jacknut hardware (-XXMT) must be in place on the mating board connector.



Stackable, Press-Fit, Compliant Pin/Socket

Contact spacing: 0.075" (1.91 mm)

A high-density top-of-the-stack cable mate connector configuration used for top-compliant connector mating applications.

DIMENSIONS

TABLE 1			
SIZE	A	B	C
28	1.014	0.784	0.450
52	1.464	1.234	0.900
76	1.914	1.684	1.350
100	2.364	2.134	1.800
128	2.889	2.659	2.325
152	3.339	3.109	2.775

Tolerances: ± 0.010"

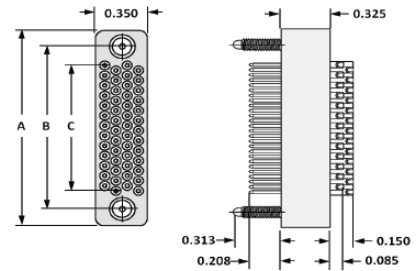

Sample Part Number Format: RC4C2-052-111-6100



SERIES
Stackable
Compliant
Full-Profile
4 Rows
0.075" Spacing
Top-of-Stack
Cable Mate

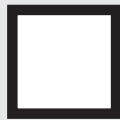

CONFIGURATION
028 – 4 Rows/7 Columns
052 – 4 Rows/13 Columns
076 – 4 Rows/19 Columns
100 – 4 Rows/25 Columns
128 – 4 Rows/32 Columns
152 – 4 Rows/38 Columns



CONTACT
11 – Pin, solder cup



PLATING
1 – 50 μ" Au
3 – 30 μ" Au



HARDWARE
00 – None
57 – Guide pin, non-polarized
61 – Jackscrew, hex, turning*



TYPE
00 – None



VARIATION
Blank – None
XXX – Consult factory



PLEASE CONSULT THE AIRBORNE WEBSITE FOR THE LATEST REVISION OF THIS DOCUMENT PRIOR TO BEGINNING ANY DESIGN WORK.

MATED HEIGHT

Connector body height is 0.325" and is designed to mount flush to the mating connector.

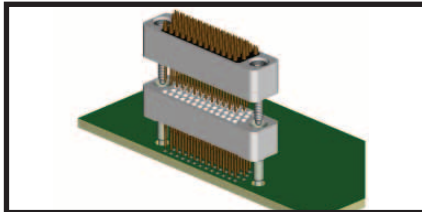
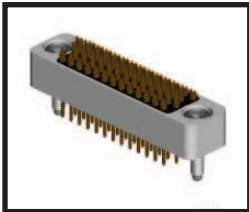

MATERIALS and FINISHES

Contact: BeCu per ASTM B196 or B197 (BeCu alloy 172 or 173)
Contact Finish: Gold per MIL-G-45204 over nickel per QQ-N-290
Molded Insulator: Glass-filled polyphenylene sulfide (PPS) per MIL-M-24519
Hardware: Stainless steel per ASTM A484/A484M and ASTM A582/A582M, passivated per SAE AMS-2700

NOTE: AirBorn can manufacture special configurations to your exact specifications.

PERFORMANCE

Contact Rating: 3 amperes
Operating Temperature: -65° C to +125° C
Insulation Resistance: 5,000 megaohms minimum @ 500 VDC
Durability: 500 connector mating cycles
Contact Resistance: 3 to 5 milliohms (contact length dependent)
Contact Engagement Force: 4.0 oz (113 g) max. w/0.0246" dia. test pin
Contact Separation Force: 0.5 oz (14 g) min. w/0.0226" dia. test pin

NOTES

* To use the -61 jackscrew hardware option, the fixed jacknut hardware (-XXMT) must be in place on the mating board connector.



RC 4-ROW DIMENSIONS

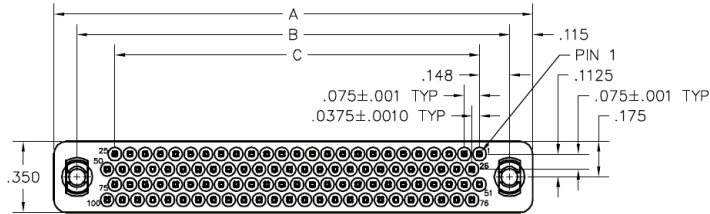

BODY STYLE 422

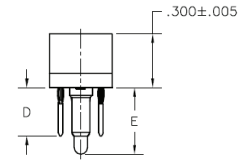

BODY STYLE 422

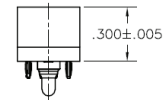

CONTACT/HARDWARE OPTION 101 (TERMINATES CIRCUIT)

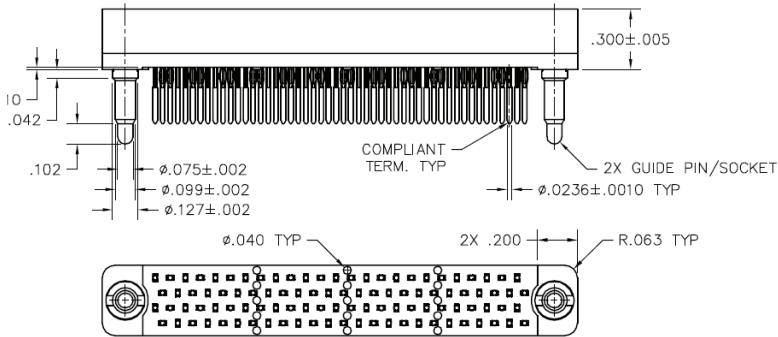

BODY STYLE 442

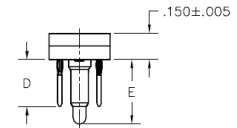

OPTIONAL INSULATOR FOR TOP CONNECTOR WITH TERMINATION OPTIONS: 301, 311, 321, 331, 341, 351, 361, 371 AND 381 (w/CIRCUIT TEST POINT).

DIMENSIONS			
SIZE	A	B	C
28	1.014	0.784	0.450
52	1.464	1.234	0.900
76	1.914	1.684	1.350
100	2.364	2.134	1.800
128	2.889	2.659	2.325
152	3.339	3.109	2.775
200	4.239	4.009	3.675
252	5.214	4.984	4.650
300	6.114	5.884	5.500

TABLE 1		
CONTACT TERMINATION	CONTACT D	HARDWARE E
201, 301	0.270	0.370
211, 311	0.300	0.400
221, 321	0.400	0.500
231, 331	0.500	0.600
241, 341	0.700	0.800
251, 351	0.800	0.900
261, 361	0.900	1.000
271, 371	0.600	0.700
281, 381	1.000	1.100
101	0.095	0.195

PWB-PLATED THRU-HOLE RECOMMENDATIONS:

Board material: FR-4 (or equivalent) with 1.0 oz. copper
Board thickness: 0.058" minimum
Drilled hole: Ø 0.033"

Copper plating thickness: 0.0020"
Tin-lead plating thickness: 0.0005"
Finished hold diameter: Ø 0.028" (Ø 0.028" ±0.002" required)



RC 4-ROW DRAWINGS

Board Footprint and Dimensions

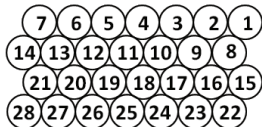
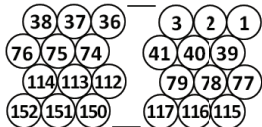
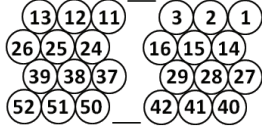
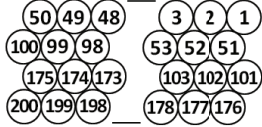
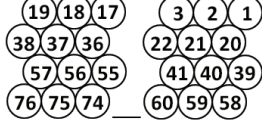
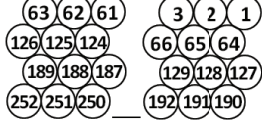
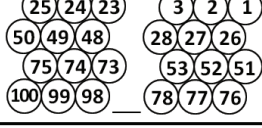
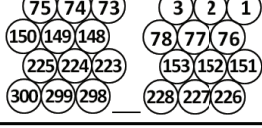
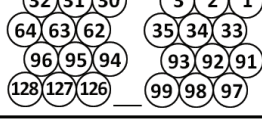
SIZE	CONTACT ID	SIZE	CONTACT ID
28		152	
52		200	
76		252	
100		300	
128			

DIMENSIONS			
SIZE	A	B	C
28	1.014	0.784	0.450
52	1.464	1.234	0.900
76	1.914	1.684	1.350
100	2.364	2.134	1.800
128	2.889	2.659	2.325
152	3.339	3.109	2.775
200	4.239	4.009	3.675
252	5.214	4.984	4.650
300	6.114	5.884	5.500

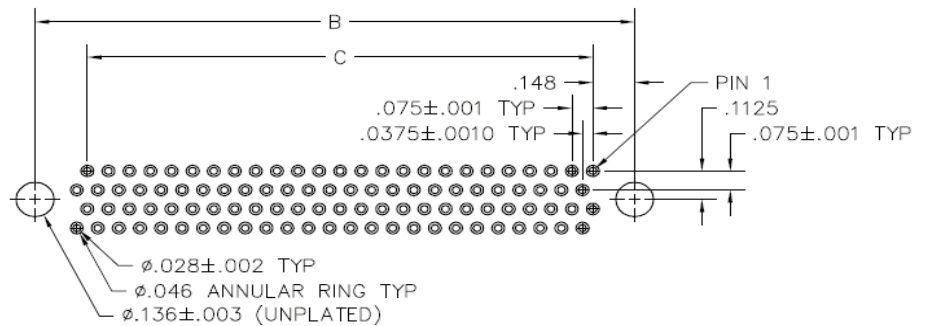

PWB-PLATED THRU-HOLE RECOMMENDATIONS:

Board material: FR-4 (or equivalent) with 1.0 oz. copper
Board thickness: 0.058" minimum
Drilled hole: Ø 0.033"

Copper plating thickness: 0.0020"
Tin-lead plating thickness: 0.0005"
Finished hold diameter: Ø 0.028" (Ø 0.028" ±0.002" required)



RC 4-ROW DIMENSIONS

Plating Options

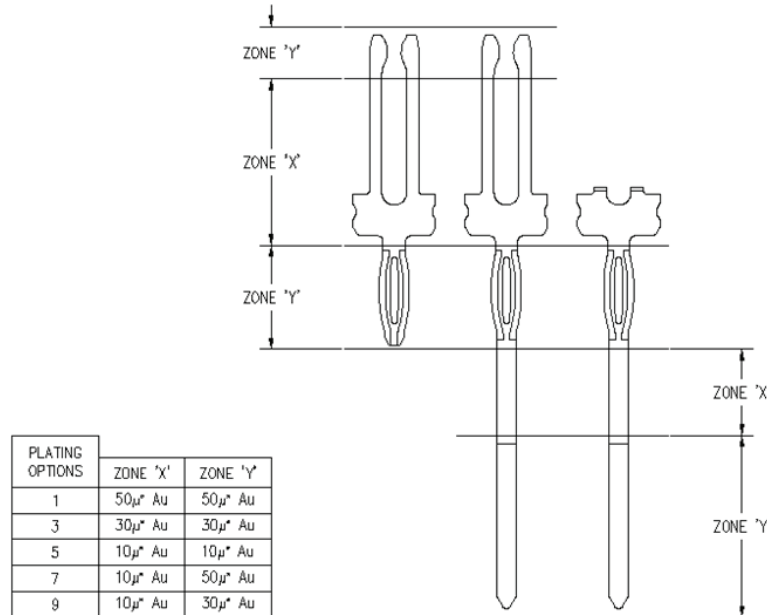

Determining the Required Termination Lead Length

To calculate the required termination lead length, use the example below. Measurements listed are in inches.

Dimension A = 0.720
 $0.720 - 0.300$ (insulator height) = 0.420
 $0.420 + 0.114$ (minimum pin engagement) = 0.534
 $0.420 + 0.214$ (maximum pin engagement) = 0.634

In this example, the termination option to choose is 0.600 lead length.

The contact termination option will be a length that falls between the calculated numbers resulting from using the minimum and maximum pin engagement.

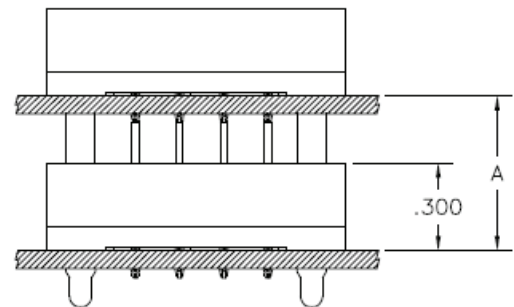

PWB-PLATED THRU-HOLE RECOMMENDATIONS:

Board material: FR-4 (or equivalent) with 1.0 oz. copper

Board thickness: 0.058" minimum

Drilled hole: \varnothing 0.033"

Copper plating thickness: 0.0020"

Tin-lead plating thickness: 0.0005"

Finished hold diameter: \varnothing 0.028" (\varnothing 0.028" \pm 0.002" required)



RC 4-ROW DRAWINGS

Stacking Detail

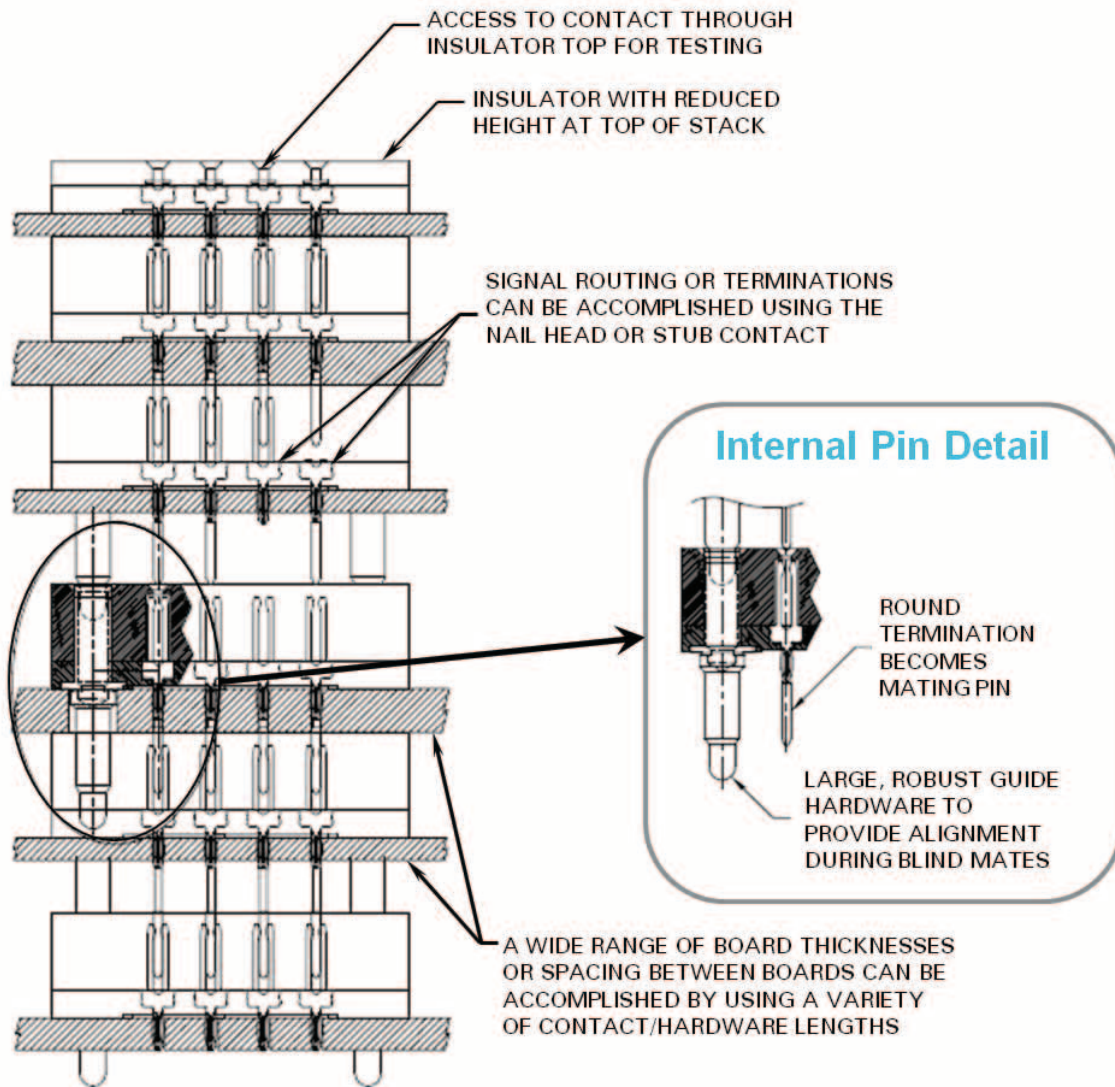

PWB-PLATED THRU-HOLE RECOMMENDATIONS:

Board material: FR-4 (or equivalent) with 1.0 oz. copper

Board thickness: 0.058" minimum

Drilled hole: \varnothing 0.033"

Copper plating thickness: 0.0020"

Tin-lead plating thickness: 0.0005"

Finished hold diameter: \varnothing 0.028" (\varnothing 0.028" \pm 0.002" required)



RC 4-ROW, BOTTOM-COMPLIANT DIMENSIONS

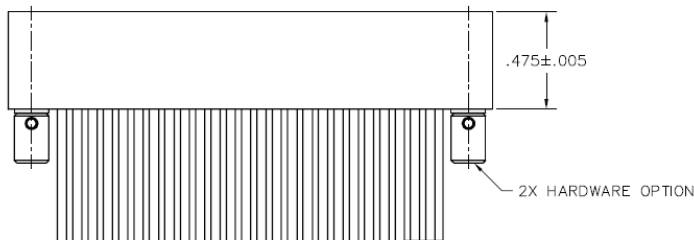
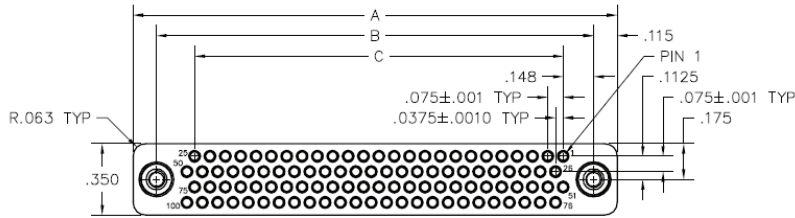

DIMENSIONS			
SIZE	A	B	C
28	1.014	0.784	0.450
52	1.464	1.234	0.900
76	1.914	1.684	1.350
100	2.364	2.134	1.800
128	2.889	2.659	2.325
152	3.339	3.109	2.775
200	4.239	4.009	3.675

GUIDE SOCKET



HARDWARE STYLE 58

#2-56 JACKSOCKET



HARDWARE STYLE 62

PWB-PLATED THRU-HOLE RECOMMENDATIONS:

Board material: FR-4 (or equivalent) with 1.0 oz. copper

Board thickness: 0.058" minimum

Drilled hole: Ø 0.033"

Copper plating thickness: 0.0020"

Tin-lead plating thickness: 0.0005"

Finished hold diameter: Ø 0.028" (Ø 0.028" ±0.002" required)



RC 4-ROW, BOTTOM-COMPLIANT DRAWINGS

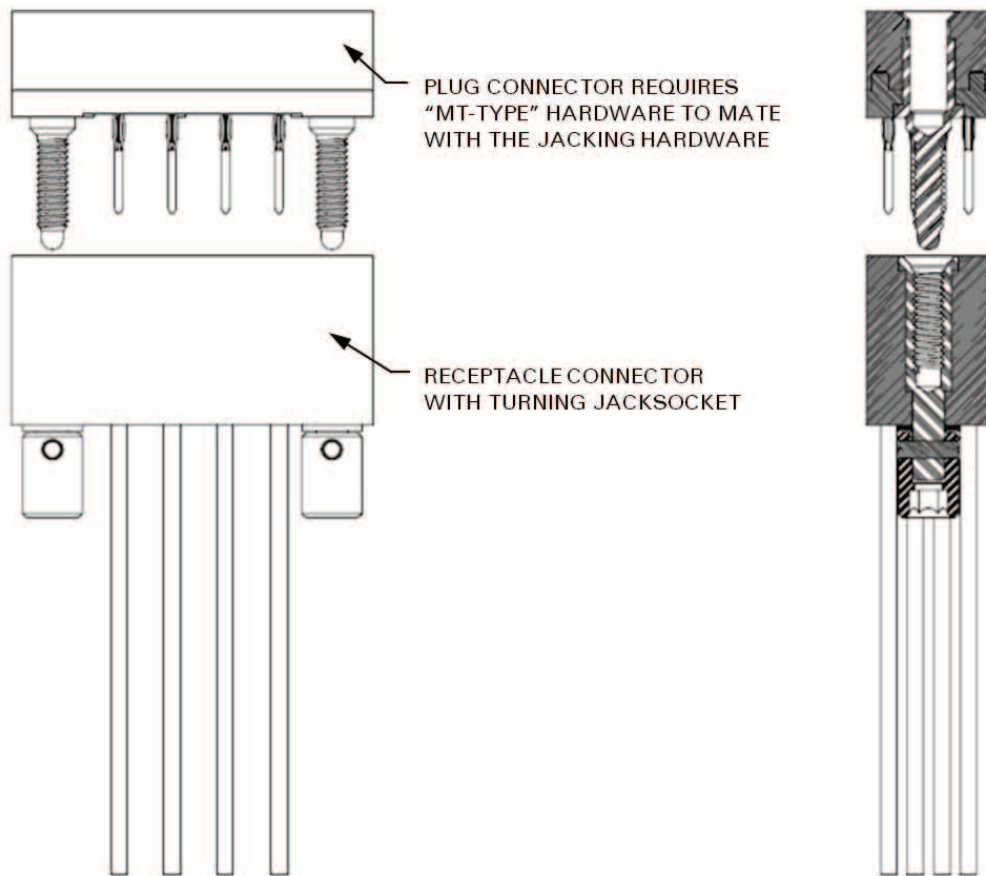

PWB-PLATED THRU-HOLE RECOMMENDATIONS:

Board material: FR-4 (or equivalent) with 1.0 oz. copper

Board thickness: 0.058" minimum

Drilled hole: \varnothing 0.033"

Copper plating thickness: 0.0020"

Tin-lead plating thickness: 0.0005"

Finished hold diameter: \varnothing 0.028" (\varnothing 0.028" \pm 0.002" required)



RC 4-ROW, TOP-COMPLIANT DIMENSIONS

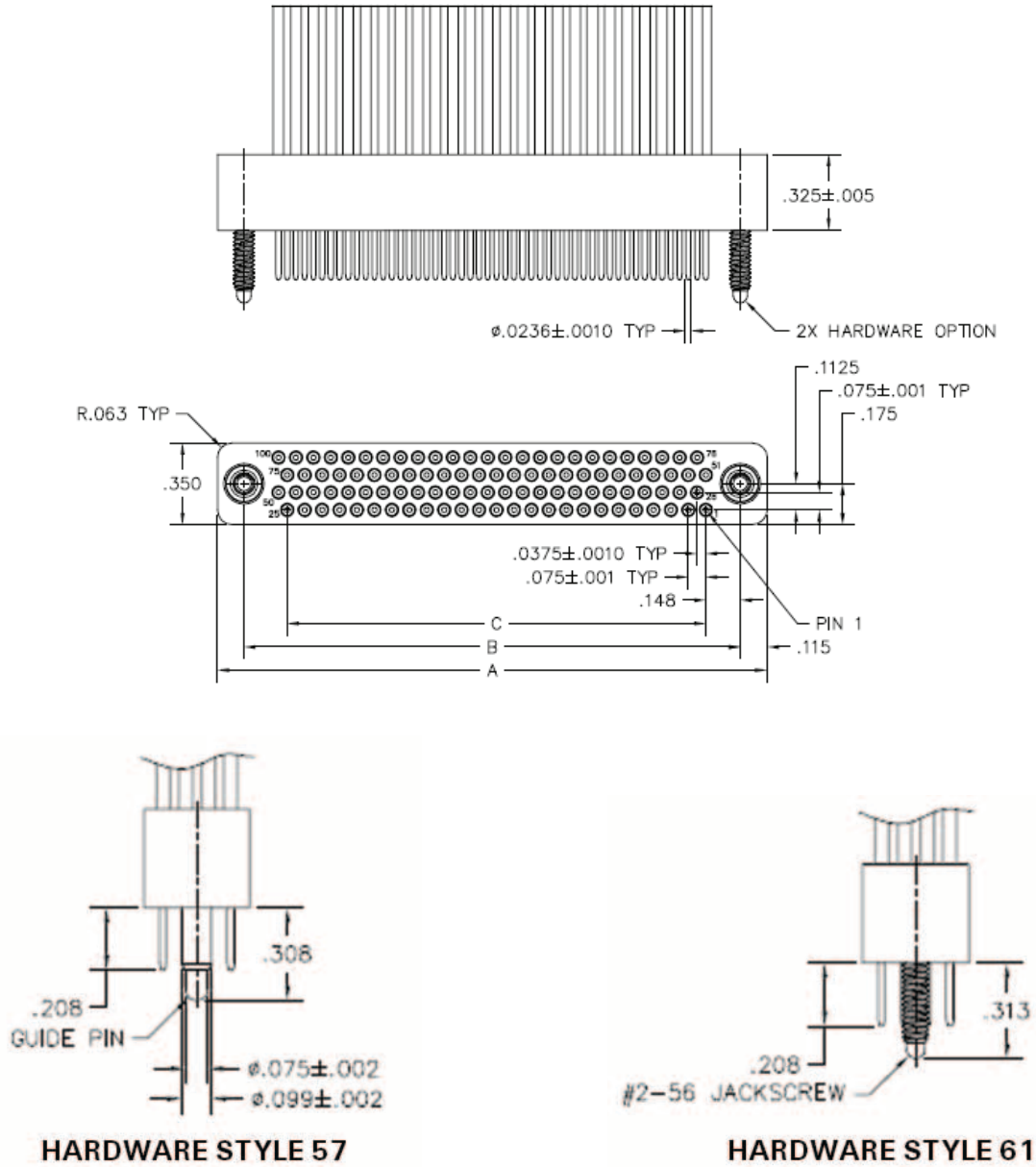

PWB-PLATED THRU-HOLE RECOMMENDATIONS:

Board material: FR-4 (or equivalent) with 1.0 oz. copper

Board thickness: 0.058" minimum

Drilled hole: $\phi 0.033$ "

Copper plating thickness: 0.0020"

Tin-lead plating thickness: 0.0005"

Finished hold diameter: $\phi 0.028$ " ($\phi 0.028$ " ± 0.002 " required)



RC 4-ROW, TOP-COMPLIANT DRAWINGS

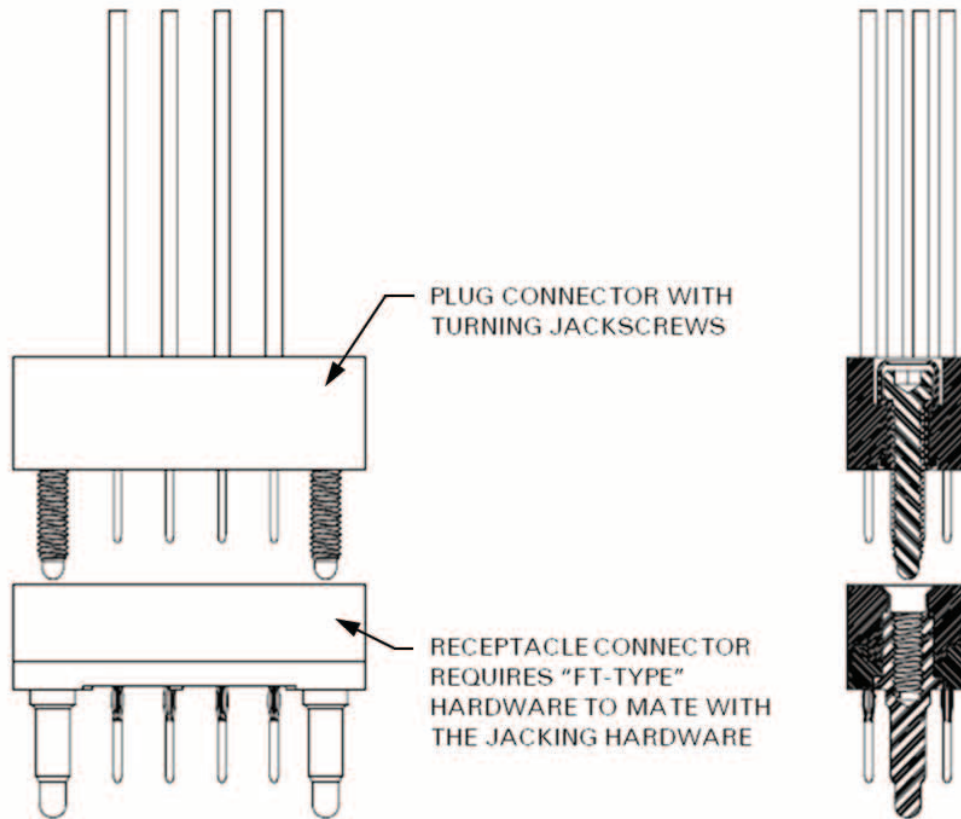

PWB-PLATED THRU-HOLE RECOMMENDATIONS:

Board material: FR-4 (or equivalent) with 1.0 oz. copper

Board thickness: 0.058" minimum

Drilled hole: \varnothing 0.033"

Copper plating thickness: 0.0020"

Tin-lead plating thickness: 0.0005"

Finished hold diameter: \varnothing 0.028" (\varnothing 0.028" \pm 0.002" required)